

RECHTE PUSH-IN FITTING Ø10 PPSU

Product Images

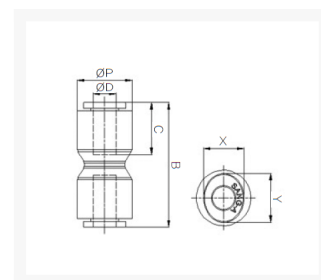

Omschrijving

De push-in fitting heeft een PPSU body, de draad is uitgevoerd in RVS316.

Afmetingen

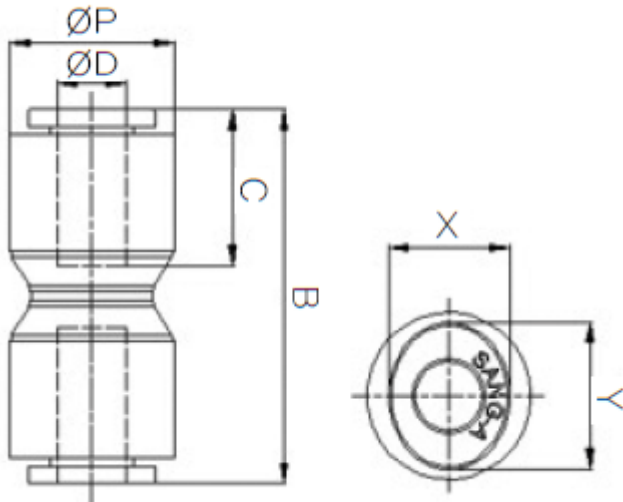

MODEL	$\varnothing D$	$\varnothing P$	B	C	X	Y
HR-PUC 04	4	11.9	31	14.9	8.6	10.8
HR-PUC 06	6	14.9	33.4	15.7	11	13
HR-PUC 08	8	16.9	37.6	17.8	13	15
HR-PUC 10	10	19.5	42.3	19.8	16	18.5
HR-PUC 12	12	23.5	48.8	22.4	19.5	22.5

Additional Information

EAN Code	8719426563441
Artikelnummer	HRPUC10
Fabrikant	Sang-A
Model	Rechte verbinding
Diameter 1	10mm
Materiaal	PPSU