

T- OPSCHROEF PIF Ø10-G1/4 PPSU

Product Images

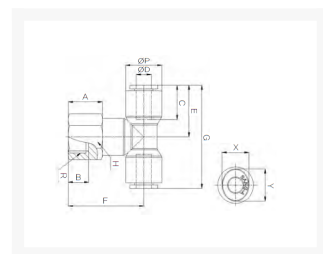

Afmetingen

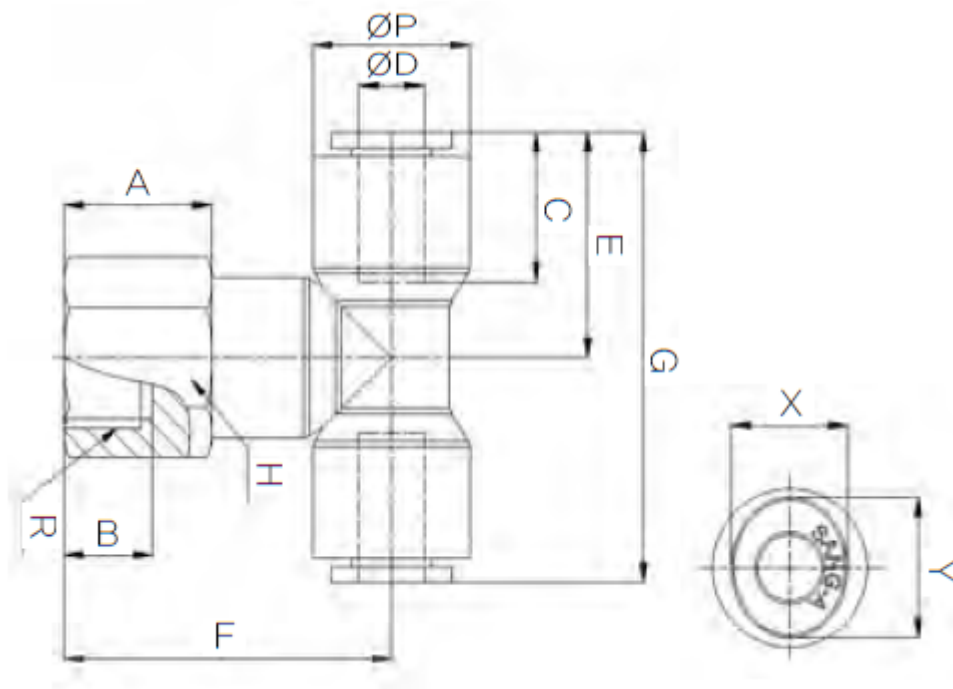

MODEL	ØD	ØP	A	B	C	E	F	G	R	H	X	Y
HR-PTF 04G01	4	11.9	10	9	14.9	18.5	24.5	37	PF 1/8	13	8.6	10.8
HR-PTF 04G02	4	11.9	14	12	14.9	18.5	28.5	37	PF 1/4	16	8.6	10.8
HR-PTF 06G01	6	14.9	10	9	15.7	21	27	42	PF 1/8	15	11	13
HR-PTF 06G02	6	14.9	14	12	15.7	21	31	42	PF 1/4	16	11	13
HR-PTF 08G01	8	16.9	10	9	17.8	23.6	29	47.2	PF 1/8	17	13	15
HR-PTF 08G02	8	16.9	14	12	17.8	23.6	33	47.2	PF 1/4	17	13	15
HR-PTF 08G03	8	16.9	15	13	17.8	23.6	34	47.2	PF 3/8	19	13	15
HR-PTF 10G02	10	19.5	14	12	19.8	26.4	35	52.8	PF 1/4	20	16	18.5
HR-PTF 10G03	10	19.5	15	13	19.8	26.4	36	52.8	PF 3/8	20	16	18.5
HR-PTF 10G04	10	19.5	19	16	19.8	26.4	40	52.8	PF 1/2	24	16	18.5
HR-PTF 12G02	12	23.5	14	12	22.4	30.9	39	61.8	PF 1/4	24	19.5	22.5
HR-PTF 12G03	12	23.5	15	13	22.4	30.9	40	61.8	PF 3/8	24	19.5	22.5
HR-PTF 12G04	12	23.5	19	16	22.4	30.9	44	61.8	PF 1/2	24	19.5	22.5

Additional Information

EAN Code	8719426565049
Artikelnummer	HRPTF10-G02
Aansluiting 1	Binnendraad
Merk	Sang-A
Fabrikant	Sang-A
Materiaal	PPSU
Diameter	10mm
Draadmaat 1	1/4"
Draadsoort 1	BSPP
Vorm	T