

T- OPSCHROEF PIF Ø10-R1/4 PPSU

Product Images

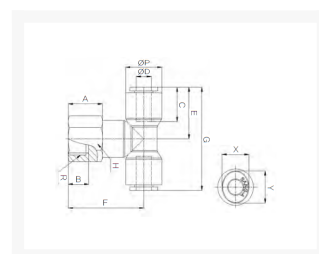

Afmetingen

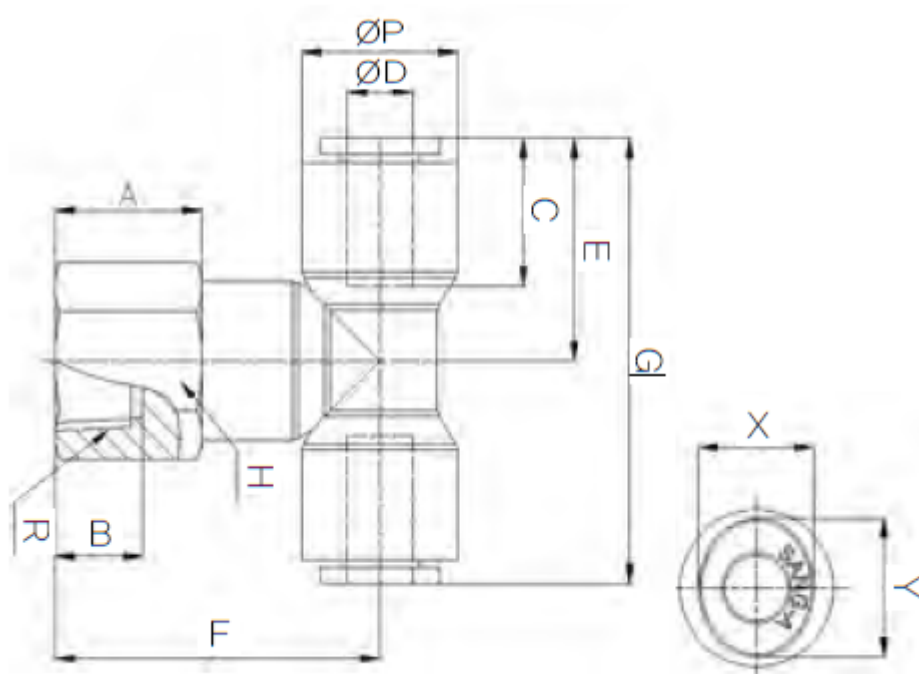

MODEL	ØD	ØP	A	B	C	E	F	G	R	H	X	Y
HR-PTF 04M5	4	11.9	8	5	14.9	18.5	22.5	37	M5	13	8.6	10.8
HR-PTF 0401	4	11.9	11	9	14.9	18.5	22.5	37	PT 1/8	13	8.6	10.8
HR-PTF 0402	4	11.9	14	12	14.9	18.5	28.5	37	PT 1/4	16	8.6	10.8
HR-PTF 06M5	6	14.9	8	5	15.7	21	25	42	M5	15	11	13
HR-PTF 0601	6	14.9	11	9	15.7	21	28	42	PT 1/8	15	11	13
HR-PTF 0602	6	14.9	14	12	15.7	21	31	42	PT 1/4	16	11	13
HR-PTF 0801	8	16.9	10	9	17.8	23.6	29	47.2	PT 1/8	17	13	15
HR-PTF 0802	8	16.9	14	12	17.8	23.6	33	47.2	PT 1/4	17	13	15
HR-PTF 0803	8	16.9	15	13	17.8	23.6	34	47.2	PT 3/8	19	13	15
HR-PTF 1002	10	19.5	14	12	19.8	26.4	35	52.8	PT 1/4	20	16	18.5
HR-PTF 1003	10	19.5	15	13	19.8	26.4	36	52.8	PT 3/8	20	16	18.5
HR-PTF 1004	10	19.5	19	16	19.8	26.4	40	52.8	PT 1/2	24	16	18.5
HR-PTF 1202	12	23.5	14	12	22.4	30.9	39	61.8	PT 1/4	24	19.5	22.5
HR-PTF 1203	12	23.5	15	13	22.4	30.9	40	61.8	PT 3/8	24	19.5	22.5

HR-PTF 1204	12	23.5	19	16	22.4	30.9	44	61.8	PT 1/2	24	19.5	22.5
----------------	----	------	----	----	------	------	----	------	--------	----	------	------

Additional Information

EAN Code	8719426565018
Artikelnummer	HRPTF10-02
Aansluiting 1	Binnendraad
Merk	Sang-A
Fabrikant	Sang-A
Materiaal	PPSU
Diameter	10mm
Draadmaat 1	1/4"
Draadsoort 1	BSPT
Vorm	T