

# T- INSCHROEF PIF Ø04-G1/4 PPSU

## Product Images

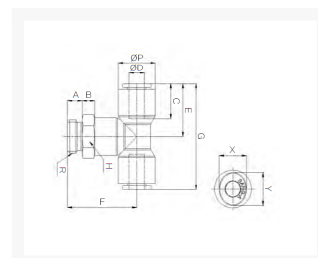

## Omschrijving

De push-in fitting heeft een PPSU body, de draad is uitgevoerd in RVS316.

## Afmetingen

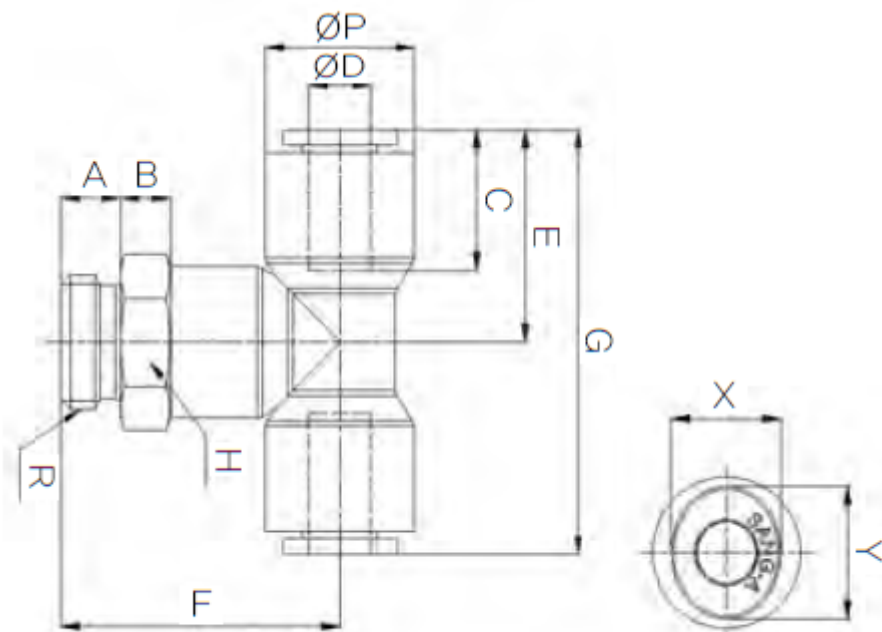

MODEL	ØD	ØP	A	B	C	E	F	G	R	H	X	Y
HR-PT 04G01	4	11.9	5.3	8	14.9	18.5	27.8	37	PF 1/8	13	8.6	10.8
HR-PT 04G02	4	11.9	6	8	14.9	18.5	28.5	37	PF 1/4	17	8.6	10.8
HR-PT 06G01	6	14.9	5.3	8	15.7	21	30.3	42	PF 1/8	15	11	13
HR-PT 06G02	6	14.9	6	8	15.7	21	31	42	PF 1/4	17	11	13
HR-PT 08G01	8	16.9	5.3	8	17.8	23.6	32.3	47.2	PF 1/8	17	13	15
HR-PT 08G02	8	16.9	6	8	17.8	23.6	33	47.2	PF 1/4	17	13	15
HR-PT 08G03	8	16.9	7	8	17.8	23.6	34	47.2	PF 3/8	20	13	15
HR-PT 10G02	10	19.5	6	8	19.8	26.4	35	52.8	PF 1/4	20	16	18.5
HR-PT 10G03	10	19.5	7	8	19.8	26.4	36	52.8	PF 3/8	20	16	18.5
HR-PT 10G04	10	19.5	8.5	8	19.8	26.4	37.5	52.8	PF 1/2	24	16	18.5
HR-PT 12G02	12	23.5	6	8	22.4	30.9	39	61.8	PF 1/4	24	19.5	22.5
HR-PT 12G03	12	23.5	7	8	22.4	30.9	40	61.8	PF 3/8	24	19.5	22.5
HR-PT 12G04	12	23.5	8.5	8	22.4	30.9	41.5	61.8	PF 1/2	24	19.5	22.5

## Additional Information

---

EAN Code	8719426563175
Artikelnummer	HRPT04-G02
Aansluiting 1	Buitendraad
Merk	Sang-A
Fabrikant	Sang-A
Materiaal	PPSU
Diameter	4mm
Draadmaat 1	1/4"
Draadsoort 1	BSPP
Vorm	T