

RECHTE INSCHR. PIF Ø10-R1/4 PPSU

Product Images

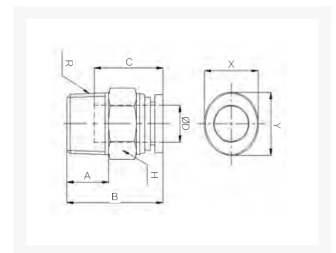

Omschrijving

De push-in fitting heeft een PPSU body, de draad is uitgevoerd in RVS316.

Afmetingen

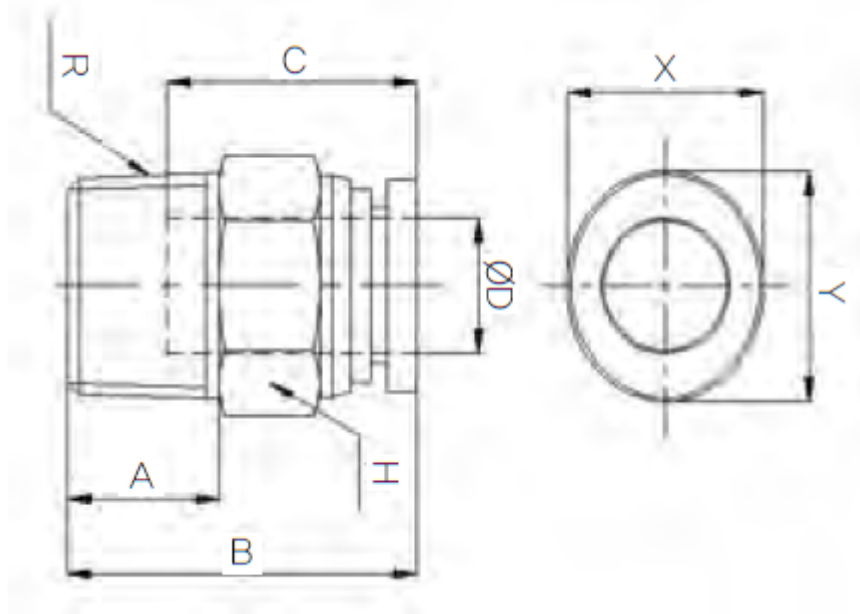

MODEL	ØD	A	B	C	H	R	X	Y
HR-PC 04M5	4	4	20.4	14.9	10	M5	8.6	10.8
HR-PC 0401	4	8	22.5	14.9	10	PT1/8	8.6	10.8
HR-PC 06M5	6	4	21.65	15.7	13	M5	11	13
HR-PC 0601	6	8	22.25	15.7	13	PT1/8	11	13
HR-PC 0602	6	11	25.25	15.7	14	PT1/4	11	13
HR-PC 0801	8	8	26.7	17.75	14	PT1/8	13	15
HR-PC 0802	8	11	26.2	17.75	14	PT1/4	13	15
HR-PC 1002	10	11	32.7	19.8	17	PT1/4	16	18.5
HR-PC 1003	10	12	27.7	19.8	17	PT3/8	16	18.5

HR-PC 1203	12	12	31.3	22.4	20	PT3/8	19.5	22.5
HR-PC 1204	12	15	32.3	22.4	21	PT1/2	19.5	22.5

Additional Information

EAN Code	8719426562772
Artikelnummer	HRPC10-02
Aansluiting 1	Buitendraad
Merk	Sang-A
Fabrikant	Sang-A
Materiaal	PPSU
Diameter	10mm
Draadmaat 1	1/4"
Draadsoort 1	BSPT
Vorm	Recht