

RECHTE INSCHR. PIF Ø04-G1/8 PPSU

Product Images

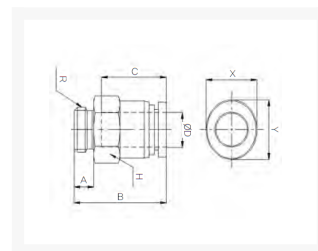

Omschrijving

De push-in fitting heeft een PPSU body, de draad is uitgevoerd in RVS316.

Afmetingen

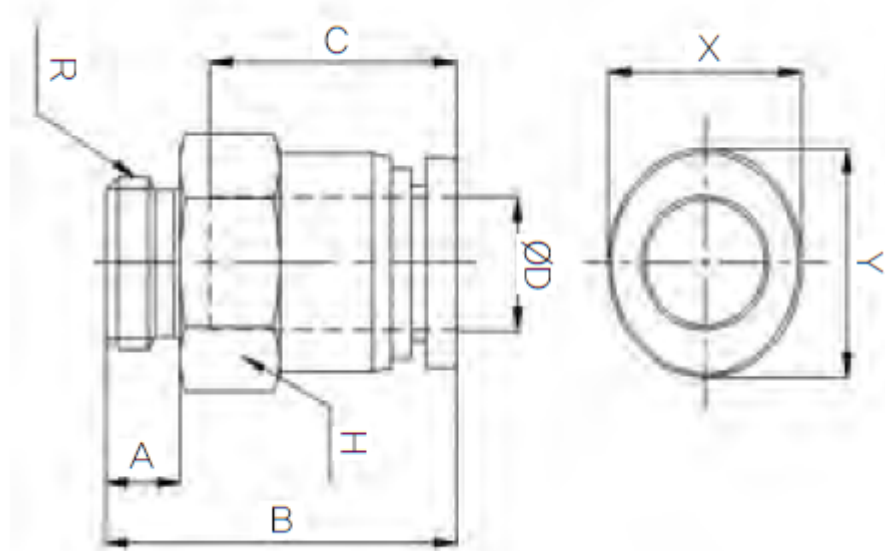

MODEL	ØD	A	B	C	H	R	X	Y
HR-PC 04G01	4	5.3	19.8	14.9	14	PF1/8	8.6	10.8
HR-PC 06G01	6	5.3	23.05	15.7	14	PF1/8	11	13
HR-PC 06G02	6	6	20.25	15.7	17	PF1/4	11	13
HR-PC 08G01	8	5.3	25.5	17.75	14	PF1/8	13	15
HR-PC 08G02	8	6	21.7	17.75	17	PF1/4	13	15
HR-PC 10G02	10	6	28.2	19.8	17	PF1/4	16	18.5
HR-PC 10G03	10	7	24.7	19.8	21	PF3/8	16	18.5
HR-PC 12G03	12	7	31.8	22.4	21	PF3/8	19.5	22.5
HR-PC 12G04	12	8.5	28.8	22.4	24	PF1/2	19.5	22.5

Additional Information

EAN Code	8719426562673
Artikelnummer	HRPC04-G01
Aansluiting 1	Buitendraad
Merk	Sang-A
Fabrikant	Sang-A
Materiaal	PPSU
Diameter	4mm
Draadmaat 1	1/8"
Draadsoort 1	BSPP
Vorm	Recht