

HAAKSE INSCHR. PIF Ø04-R1/8 PPSU

Product Images

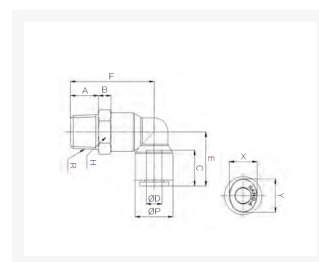

Omschrijving

De push-in fitting heeft een PPSU body, de draad is uitgevoerd in RVS316.

Afmetingen

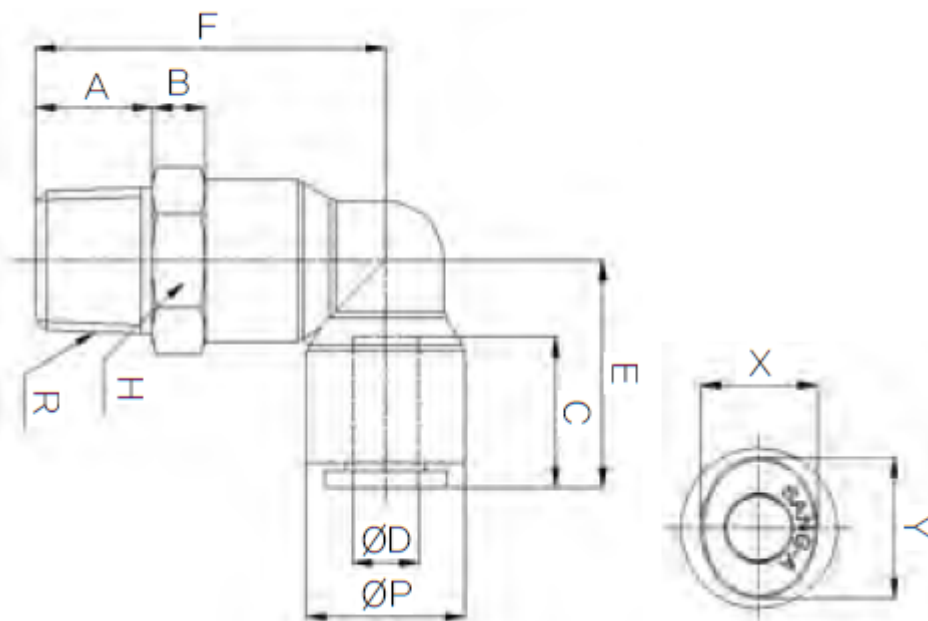

MODEL	ØD	ØP	A	B	C	E	F	R	H	X	Y
HR-PL 04M5	4	11.9	4	8	14.9	18.5	26.5	M5	13	8.6	10.8
HR-PL 0401	4	11.9	8	8	14.9	18.5	30.5	PT 1/8	13	8.6	10.8
HR-PL 0402	4	11.9	11	8	14.9	18.5	33.5	PT 1/4	14	8.6	10.8
HR-PL 06M5	6	14.9	4	8	15.7	21	29	M5	15	11	13
HR-PL 0601	6	14.9	8	8	15.7	21	33	PT 1/8	15	11	13
HR-PL 0602	6	14.9	11	8	15.7	21	36	PT 1/4	15	11	13
HR-PL 0801	8	16.9	8	8	17.8	23.6	35	PT 1/8	17	13	15
HR-PL 0802	8	16.9	11	8	17.8	23.6	38	PT 1/4	17	13	15
HR-PL 0803	8	16.9	12	8	17.8	23.6	39	PT 3/8	17	13	15
HR-PL 1002	10	19.5	11	8	19.8	26.4	40	PT 1/4	20	16	18.5
HR-PL 1003	10	19.5	12	8	19.8	26.4	41	PT 3/8	20	16	18.5
HR-PL 1004	10	19.5	15	8	19.8	26.4	44	PT 1/2	21	16	18.5

HR-PL 1202	12	23.5	11	8	22.4	30.9	44	PT 1/4	24	19.5	22.5
HR-PL 1203	12	23.5	12	8	22.4	30.9	45	PT 3/8	24	19.5	22.5
HR-PL 1204	12	23.5	15	8	22.4	30.9	48	PT 1/2	24	19.5	22.5

Additional Information

EAN Code	8719426562864
Artikelnummer	HRPL04-01
Aansluiting 1	Buitendraad
Merk	Sang-A
Fabrikant	Sang-A
Materiaal	PPSU
Diameter	4mm
Draadmaat 1	1/8"
Draadsoort 1	BSPT
Vorm	Haaks