

L-VERLOOP PIF Ø08-Ø06 PVDF

Product Images

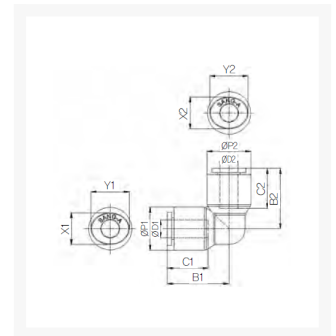

Omschrijving

De push-in fitting heeft een PVDF body, de draad is uitgevoerd in RVS316.

Afmetingen

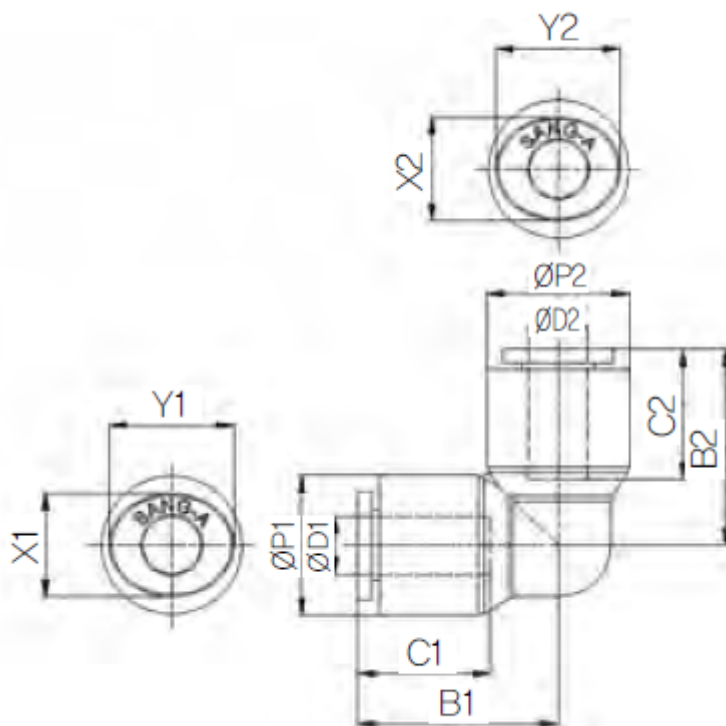

MODEL	ØD1	ØD2	ØP1	ØP2	B1	B2	C1	C2	X1	X2	Y1	Y2
CR-PUL 04	4	4	11.8	11.8	18	18	14.5	14.5	8.6	8.6	10.8	10.8
CR-PUL 06	6	6	14.7	14.7	20.6	20.6	15.6	15.6	11	11	13	13
CR-PUL 08	8	8	16.7	16.7	23.1	23.1	17.3	17.3	13	13	15	15
CR-PUL 10	10	10	19.3	19.3	25.8	25.8	19.4	19.4	16	16	18.5	18.5
CR-PUL 12	12	12	23.2	23.2	30.9	30.9	22.4	22.4	19.5	19.5	22.5	22.5
CR-PUL 0604	6	4	14.7	11.8	20.6	18	15.6	14.5	11	8.6	13	10.8
CR-PUL 0806	8	6	16.7	14.7	23.1	20.6	17.3	15.6	13	11	15	13
CR-PUL 1008	10	8	19.3	16.7	25.8	23.1	19.4	17.3	16	13	18.5	15
CR-PUL 1210	12	10	23.2	19.3	30.9	25.8	22.4	19.4	19.5	16	22.5	18.5

Additional Information

EAN Code	8719426566718
Artikelnummer	CRPUL08-06
Fabrikant	Sang-A
Model	Haakse verbinding
Diameter 1	8mm
Diameter 2	6mm
Materiaal	PVDF