

T-STEEL Ø04 PVDF

Product Images

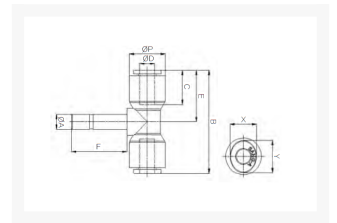

Omschrijving

De push-in fitting heeft een PVDF body, de draad is uitgevoerd in RVS316.

Afmetingen

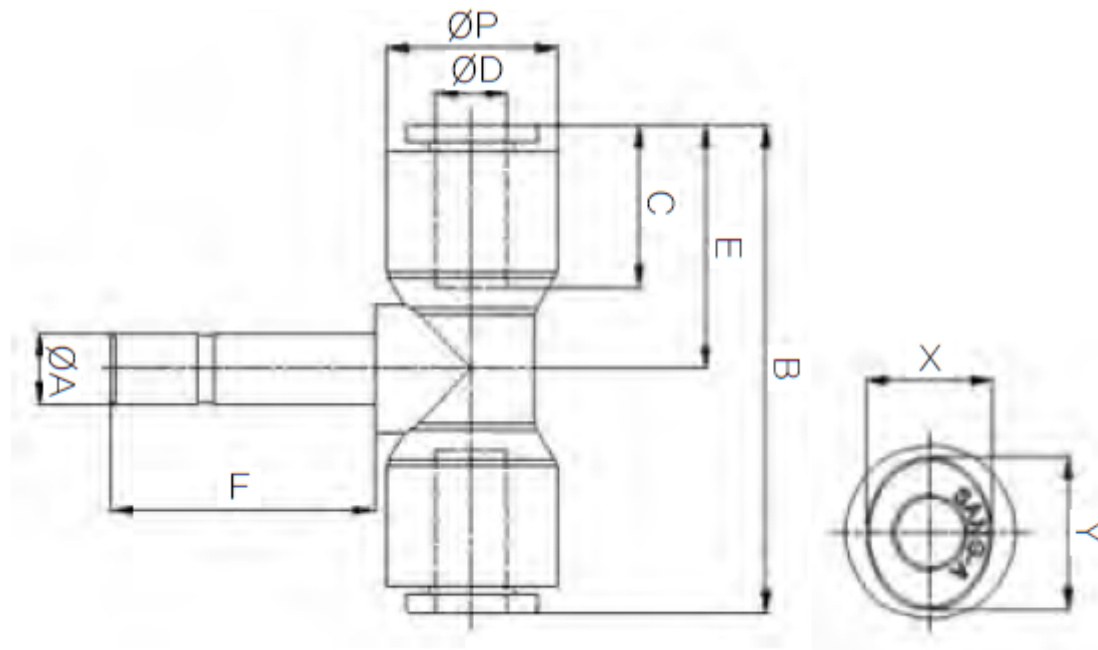

MODEL	$\varnothing D$	$\varnothing P$	$\varnothing A$	B	C	E	F	X	Y
CR-PTJ 04	4	11.9	4	36.2	14.5	18.1	17.5	8.6	10.8
CR-PTJ 06	6	14.9	6	41.8	15.6	20.9	23	11	13
CR-PTJ 08	8	16.9	8	46.2	17.3	23.1	25	13	15
CR-PTJ 10	10	19.5	10	52	19.4	26	27	16	18.5
CR-PTJ 12	12	23.5	12	61.8	22.4	30.9	29	19.5	22.5

Additional Information

EAN Code	8719426568422
Artikelnummer	CRPTJ04
Fabrikant	Sang-A
Model	T-steel
Steel	4 mm
Diameter 1	4mm
Materiaal	PVDF