

L-OPSCHROEF PIF Ø08-R1/4 PVDF

Product Images

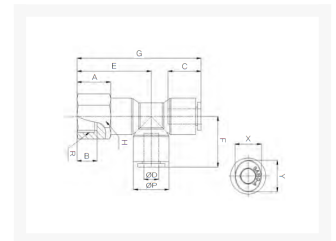

Afmetingen

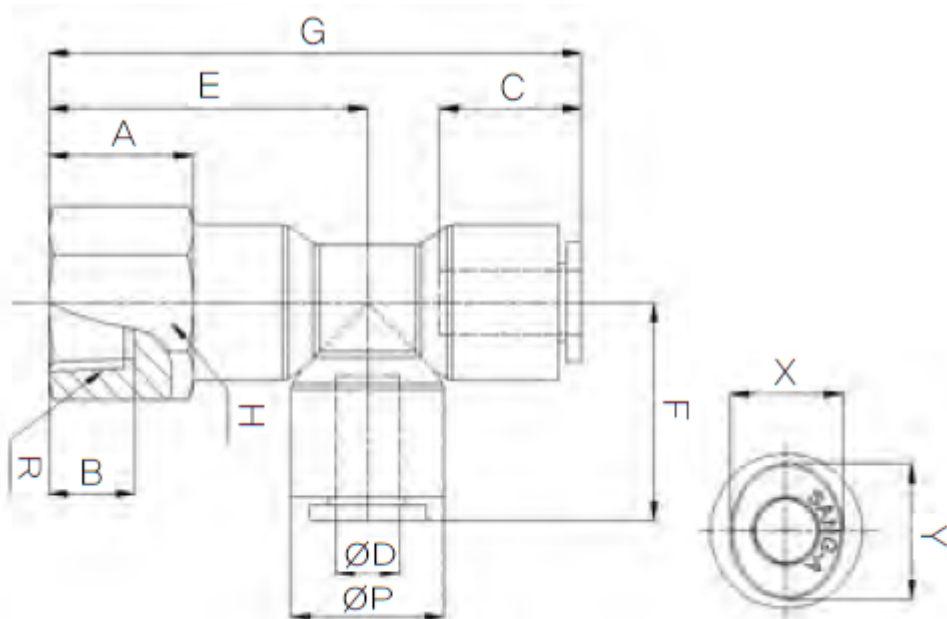

MODEL	ØD	ØP	A	B	C	E	F	G	R	H	X	Y
CR-PSTF 04M5	4	11.8	8	5	14.5	22.4	18	40.4	M5	13	8.6	10.8
CR-PSTF 0401	4	11.8	11	9	14.5	25.4	18	43.4	PT 1/8	13	8.6	10.8
CR-PSTF 0402	4	11.8	14	12	14.5	28.4	18	46.4	PT 1/4	16	8.6	10.8
CR-PSTF 06M5	6	14.7	8	5	15.6	24.7	20.6	45.3	M5	15	11	13
CR-PSTF 0601	6	14.7	11	9	15.6	27.7	20.6	48.3	PT 1/8	15	11	13
CR-PSTF 0602	6	14.7	14	12	15.6	30.7	20.6	51.3	PT 1/4	16	11	13
CR-PSTF 0801	8	16.7	10	9	17.3	29	23.1	52.1	PT 1/8	17	13	15
CR-PSTF 0802	8	16.7	14	12	17.3	33	23.1	56.1	PT 1/4	17	13	15
CR-PSTF 0803	8	16.7	15	13	17.3	34	23.1	57.1	PT 3/8	19	13	15
CR-PSTF 1002	10	19.3	14	12	19.4	34.8	25.8	60.6	PT 1/4	20	16	18.5
CR-PSTF 1003	10	19.3	15	13	19.4	35.8	25.8	61.6	PT 3/8	20	16	18.5
CR-PSTF 1004	10	19.3	19	16	19.4	39.8	25.8	65.6	PT 1/2	24	16	18.5
CR-PSTF 1202	12	23.2	14	12	22.4	39	30.9	69.9	PT 1/4	24	19.5	22.5
CR-PSTF 1203	12	23.2	15	13	22.4	40	30.9	70.9	PT 3/8	24	19.5	22.5
CR-PSTF 1204	12	23.2	19	16	22.4	44	30.9	74.9	PT 1/2	24	19.5	22.5

Additional Information

EAN Code	8719426568583
Artikelnummer	CRPSTF08-02
Aansluiting 1	Binnendraad
Merk	Sang-A
Fabrikant	Sang-A
Materiaal	PVDF
Diameter	8mm
Draadmaat 1	1/4"
Draadsoort 1	BSPT
Vorm	L