

HAAKSE OPSCHROEF PIF Ø04-R1/8 PVDF

Product Images

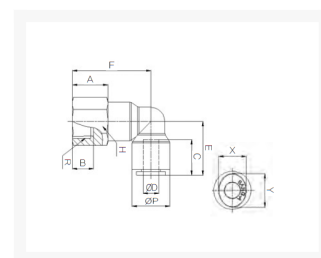

Afmetingen

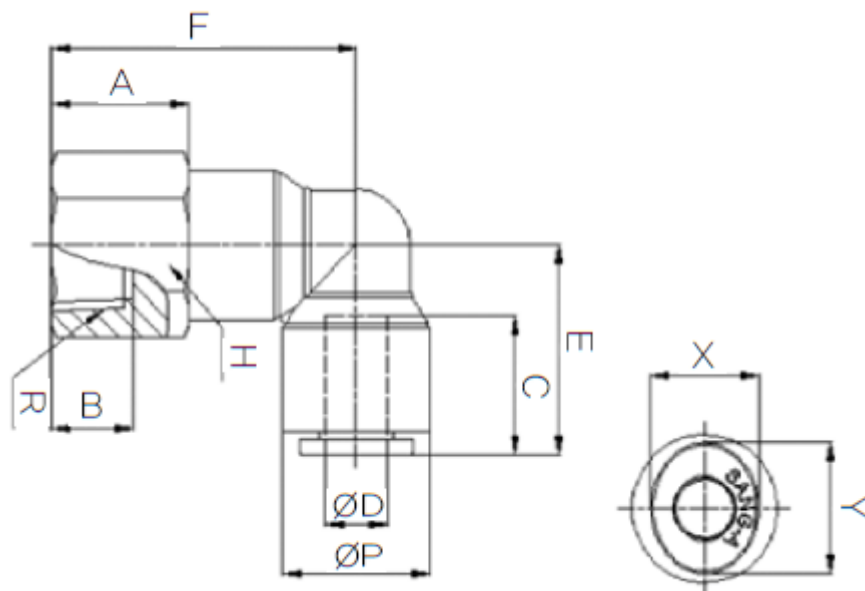

MODEL	ØD	ØP	A	B	C	E	F	R	H	X	Y
CR-PLF 04M5	4	11.8	8	5	14.5	18	22.4	M5	13	8.6	10.8
CR-PLF 0401	4	11.8	11	9	14.5	18	25.4	PT 1/8	13	8.6	10.8
CR-PLF 0402	4	11.8	14	12	14.5	18	28.4	PT 1/4	16	8.6	10.8
CR-PLF 06M5	6	14.7	8	5	15.6	20.6	24.7	M5	15	11	13
CR-PLF 0601	6	14.7	11	9	15.6	20.6	27.7	PT 1/8	15	11	13
CR-PLF 0602	6	14.7	14	12	15.6	20.6	30.7	PT 1/4	16	11	13
CR-PLF 0801	8	16.7	10	9	17.3	23.1	29	PT 1/8	17	13	15
CR-PLF 0802	8	16.7	14	12	17.3	23.1	33	PT 1/4	17	13	15
CR-PLF 0803	8	16.7	15	13	17.3	23.1	34	PT 3/8	19	13	15
CR-PLF 1002	10	19.3	14	12	19.4	25.8	34.8	PT 1/4	20	16	18.5
CR-PLF 1003	10	19.3	15	13	19.4	25.8	35.8	PT 3/8	20	16	18.5
CR-PLF 1004	10	19.3	19	16	19.4	25.8	39.8	PT 1/2	24	16	18.5
CR-PLF 1202	12	23.2	14	12	22.4	30.9	39	PT 1/4	24	19.5	22.5
CR-PLF 1203	12	23.2	15	13	22.4	30.9	40	PT 3/8	24	19.5	22.5

CR-PLF 1204	12	23.2	19	16	22.4	30.9	44	PT 1/2	24	19.5	22.5
----------------	----	------	----	----	------	------	----	--------	----	------	------

Additional Information

EAN Code	8719426567685
Artikelnummer	CRPLF04-01
Aansluiting 1	Binnendraad
Merk	Sang-A
Fabrikant	Sang-A
Materiaal	PVDF
Diameter	4mm
Draadmaat 1	1/8"
Draadsoort 1	BSPT
Vorm	Haaks