

# HAAKSE INSCHR. PIF Ø10-R1/2 PVDF

## Product Images

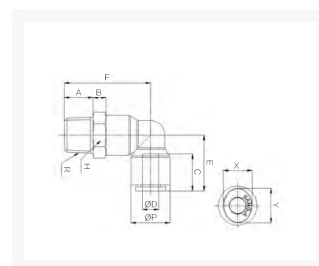

## Omschrijving

De push-in fitting heeft een PVDF body, de draad is uitgevoerd in RVS316.

## Afmetingen

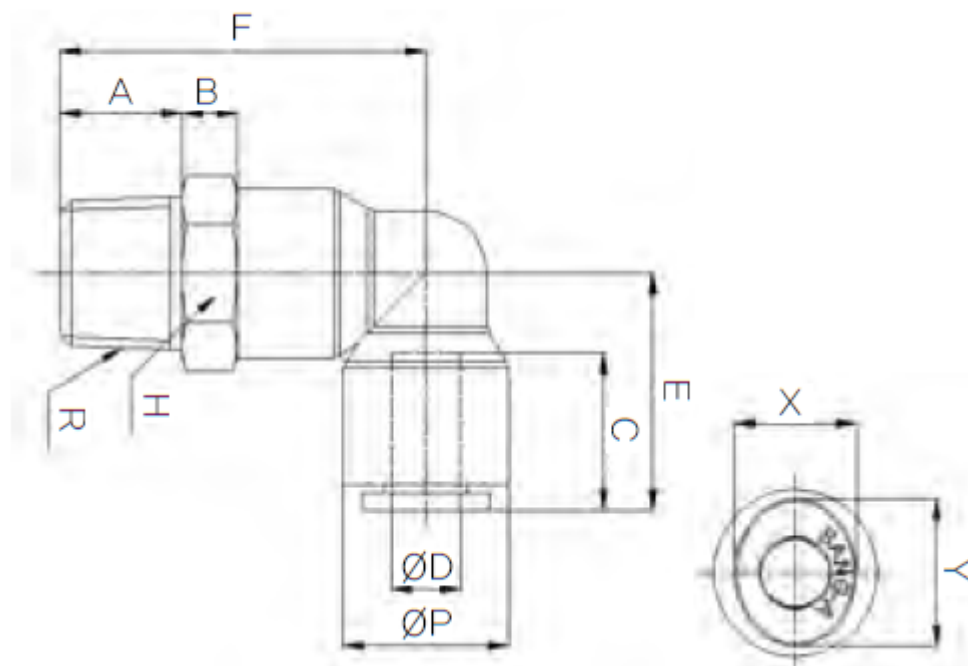

MODEL	ØD	ØP	A	B	C	E	F	R	H	X	Y
CR-PL 04M5	4	11.8	4	8	14.5	18	26.4	M5	13	8.6	10.8
CR-PL 0401	4	11.8	8	8	14.5	18	30.4	PT 1/8	13	8.6	10.8
CR-PL 0402	4	11.8	11	8	14.5	18	33.4	PT 1/4	14	8.6	10.8
CR-PL 06M5	6	14.7	4	8	15.6	20.6	28.7	M5	15	11	13
CR-PL 0601	6	14.7	8	8	15.6	20.6	32.7	PT 1/8	15	11	13
CR-PL 0602	6	14.7	11	8	15.6	20.6	35.7	PT 1/4	15	11	13
CR-PL 0801	8	16.7	8	8	17.3	23.1	35	PT 1/8	17	13	15
CR-PL 0802	8	16.7	11	8	17.3	23.1	38	PT 1/4	17	13	15
CR-PL 0803	8	16.7	12	8	17.3	23.1	39	PT 3/8	17	13	15
CR-PL 1002	10	19.3	11	8	19.4	25.8	39.8	PT 1/4	20	16	18.5
CR-PL 1003	10	19.3	12	8	19.4	25.8	40.8	PT 3/8	20	16	18.5
CR-PL 1004	10	19.3	15	8	19.4	25.8	43.8	PT 1/2	21	16	18.5

CR-PL 1202	12	23.2	11	8	22.4	30.9	44	PT 1/4	24	19.5	22.5
CR-PL 1203	12	23.2	12	8	22.4	30.9	45	PT 3/8	24	19.5	22.5
CR-PL 1204	12	23.2	15	8	22.4	30.9	48	PT 1/2	24	19.5	22.5

## Additional Information

---

EAN Code	8719426566220
Artikelnummer	CRPL10-04
Aansluiting 1	Buitendraad
Merk	Sang-A
Fabrikant	Sang-A
Materiaal	PVDF
Diameter	10mm
Draadmaat 1	1/2"
Draadsoort 1	BSPT
Vorm	Haaks